

Steel has Zinc Electroplate Finish, 1-5/8" wide x 1/4" thick. Holes are 9/16" diameter, 13/16" center to edge on 1-7/16" centers

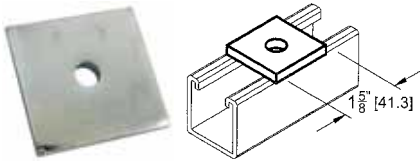

Square Washer



Dimensions = Inches

Cat. No.	Bolt Size	Hole Size	Box Qty
17612	1/4"	5/16"	100
17616	3/8"	7/16"	100
17618	1/2"	9/16"	100

2 Hole Splice Plate

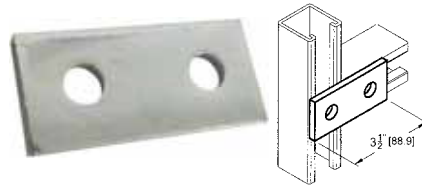

Cat. No.	Box Qty
17622	50

3 Hole Splice Plate

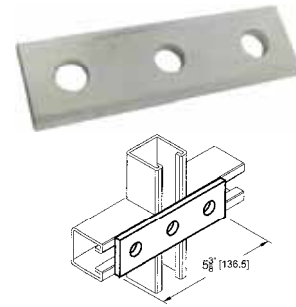

Cat. No.	Box Qty
17624	25

4 Hole Splice Plate

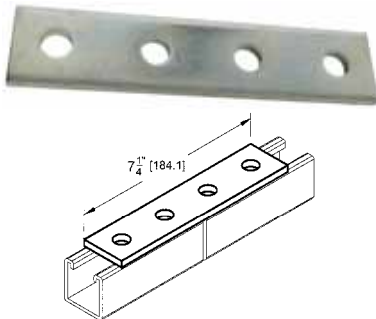

Cat. No.	Box Qty
17626	25

4 Hole Tee Plate

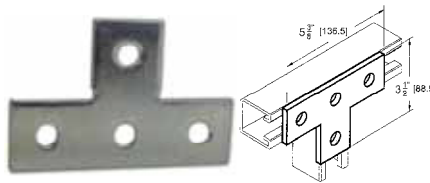

Cat. No.	Box Qty
17636	20

3 Hole Corner Plate

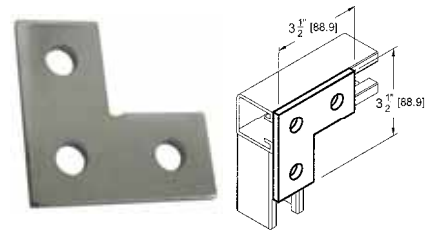

Cat. No.	Box Qty
17632	25

2 Hole Cross Corner Angle

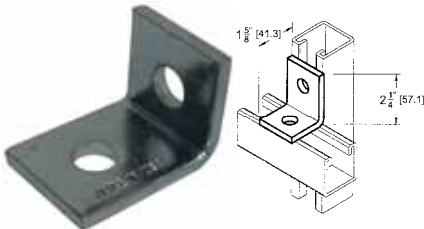

Cat. No.	Box Qty
17630	50

2 Hole Corner Angle

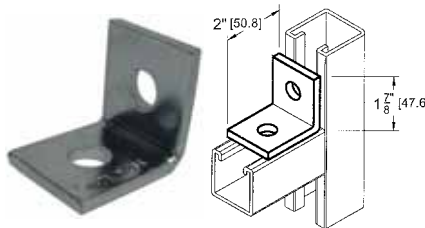

Cat. No.	Box Qty
17628	50

4 Hole 3 Way Corner Angle

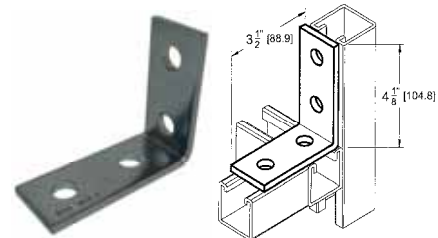

Cat. No.	Box Qty
17634	25

3 Hole Cross Corner Angle

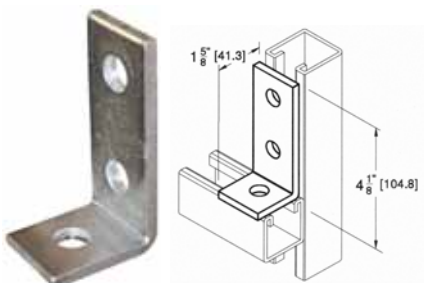

Cat. No.	Box Qty
17633	50

2 Hole Open Corner Angle

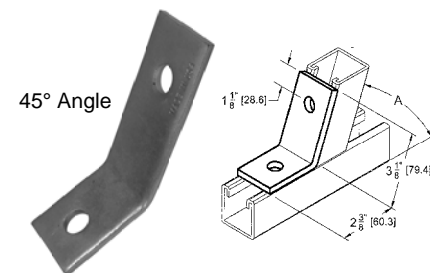

Cat. No.	Box Qty
17638	25

Plastic White End Caps

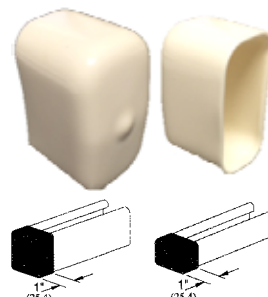

Cat. No.	Channel Used with	Box Qty
17682	13/16"	100
17684	1-5/8"	100